

1121441 * 2,140 kg/m

1121439 * 2,680 kg/m

1121443 * 3,930 kg/m

* Teleskoperande rör

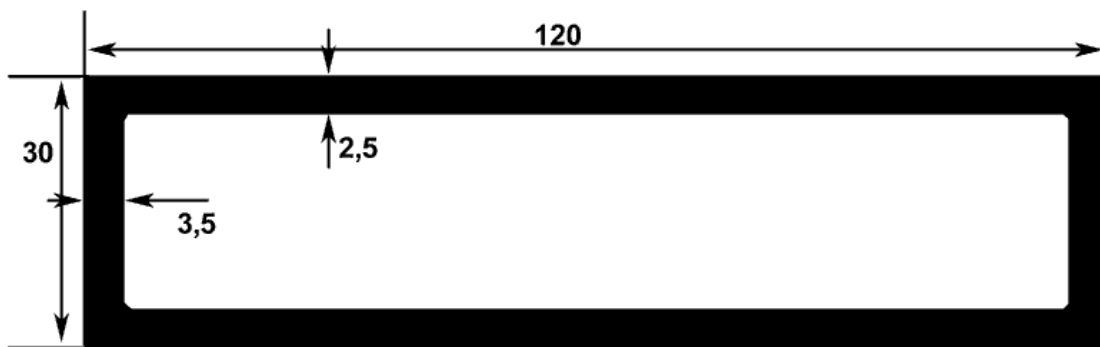

1032871
2,600 kg/m

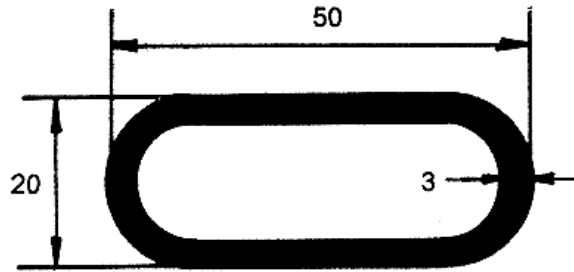

1035430
0,925 kg/m

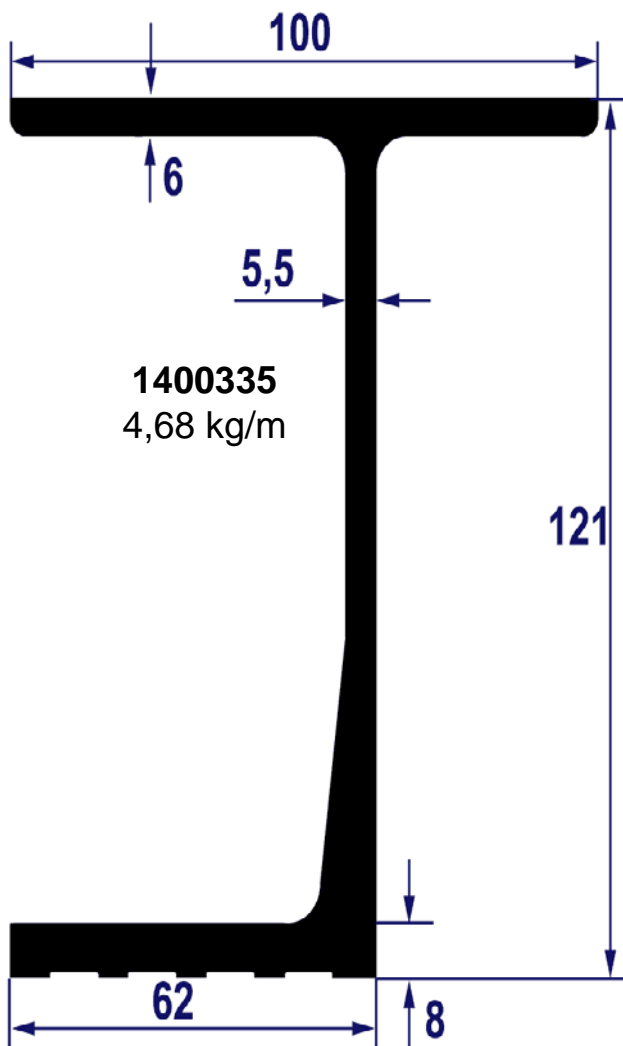

1400335
4,68 kg/m

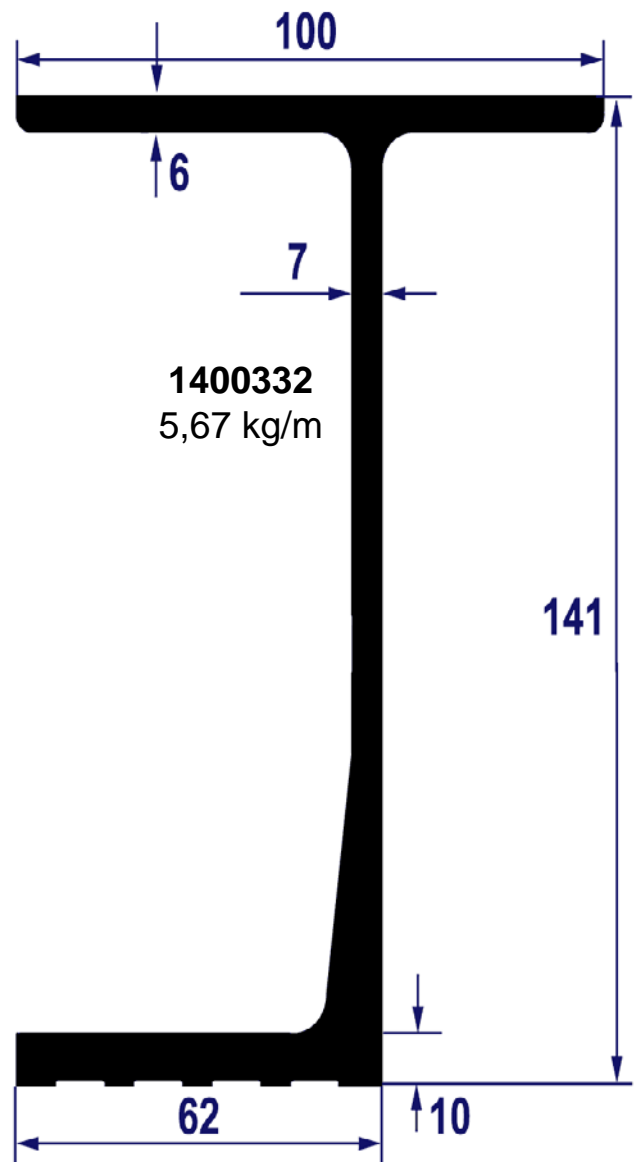

1400332
5,67 kg/m

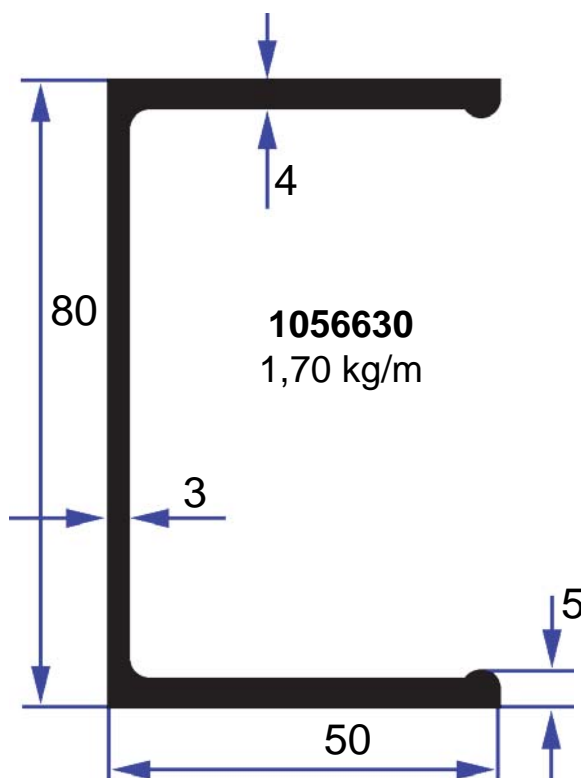
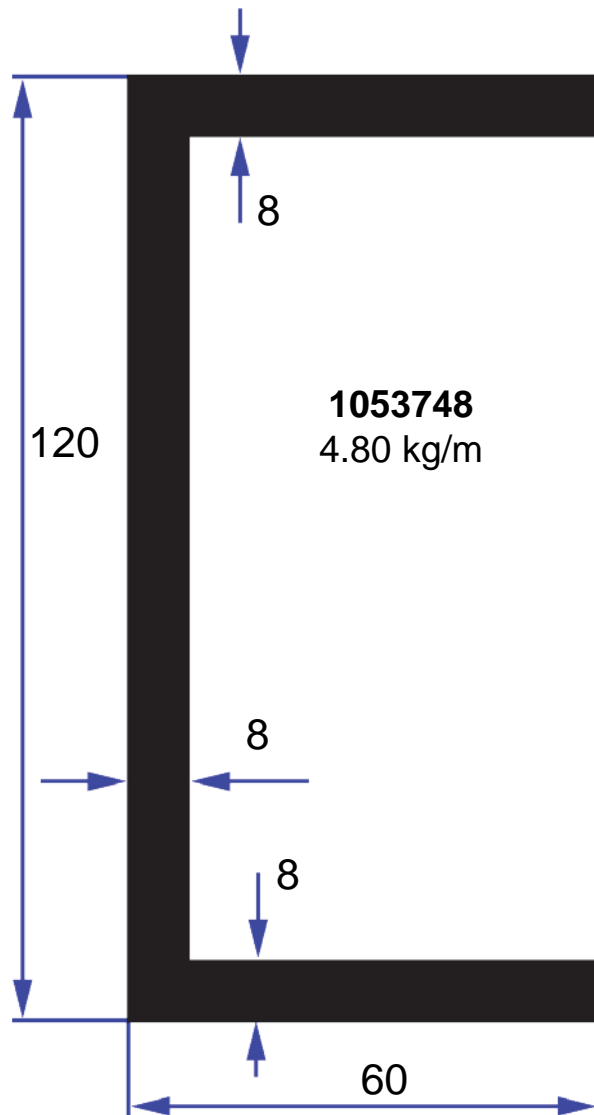

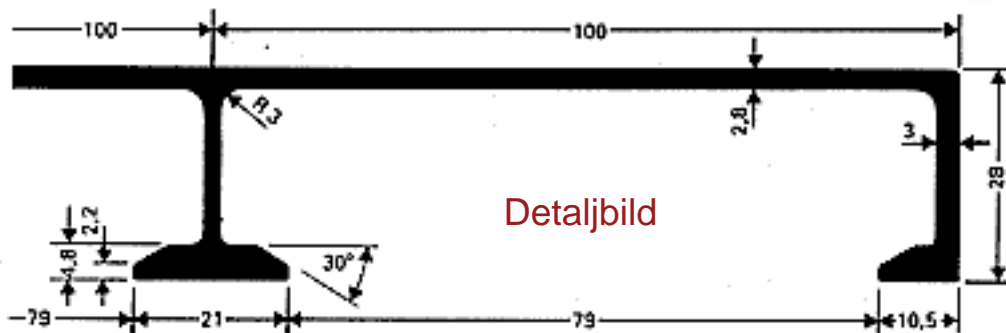
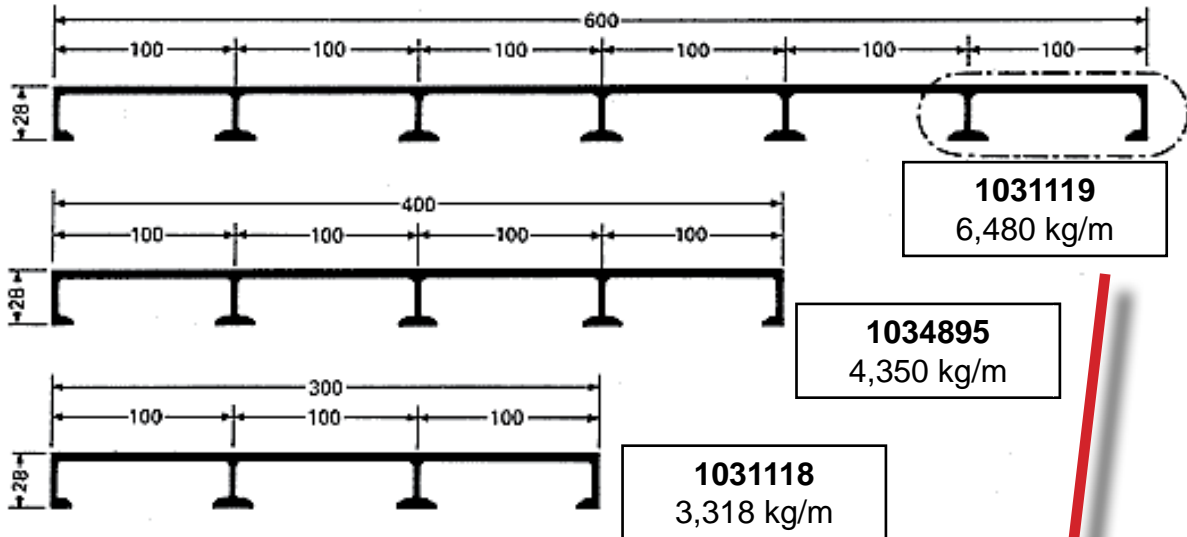
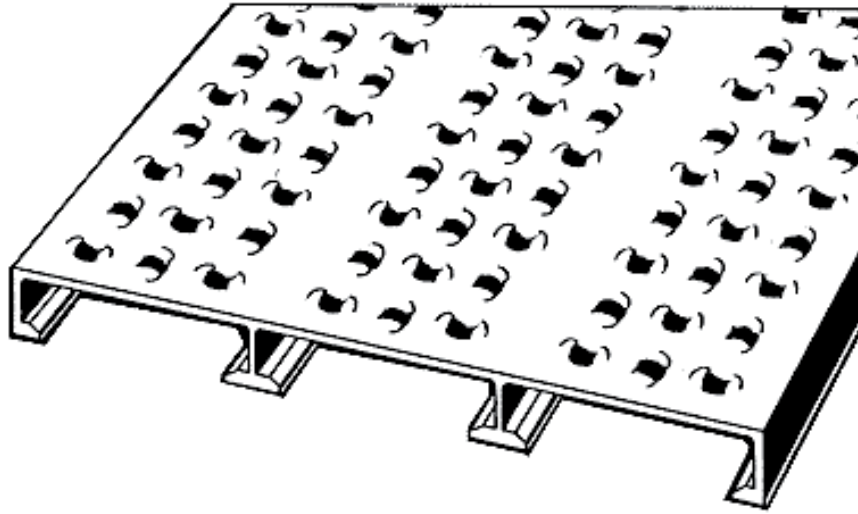

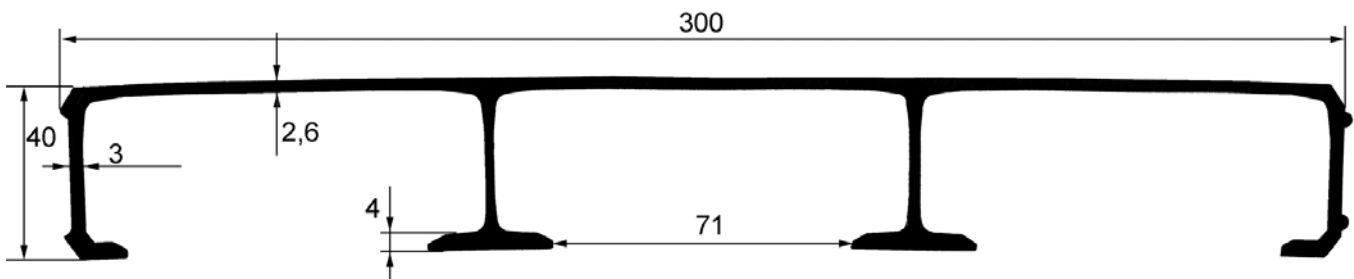

1295305
4,2 kg/m

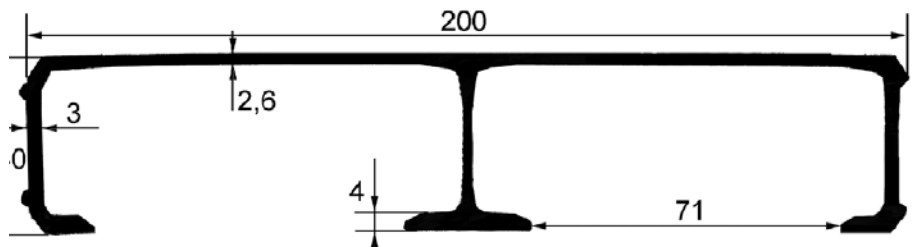

1295303
2,9 kg/m